

# An Improved Distance Relay model with Directional element, and Memory Polarization for TCD based Fault Propagation Studies

R. Jain, S. M. Lukic  
 FREEDM Systems Center  
 North Carolina State University  
 Raleigh, US  
 {rjain5, smlukic}@ncsu.edu

A. Chhokra, N.Mahadevan, A.Dubey, G. Karsai  
 Institute of Software Integrated Systems  
 Vanderbilt University  
 Nashville, TN  
 {ajay.d.chhokra, Nag, dabhishe,  
 gabor}@isis.vanderbilt.edu

**Abstract**—Modern Power Systems have evolved into a very complex network of multiple sources, lines, breakers, loads and others. The performance of these interdependent components decide the reliability of the power systems. A tool called “Reasoner” is being developed to deduce fault propagations using a Temporal Causal Diagram (TCD) approach. It translates the physical system as a Cause-effect model. This work discusses the development of an advanced distance relay model, which monitors the system, and challenges the operation of reasoner for refinement. Process of generation of a Fault and Discrepancy Mapping file from the test system is presented. This file is used by the reasoner to scrutinize relays’ responses for active system faults, and hypothesize potential mis-operations (or cyber faults) with a confidence metric. Analyzer (relay model) is integrated to OpenDSS for fault analysis. The understanding of the system interdependency (fault propagation behavior) using reasoner can make the grid more robust against cascaded failures.

**Keywords**— TCD, Temporal Causal Diagram, Distance Relay, OpenDSS, Mho Element, Directional Element, Memory Polarization, Fault Type Selection.

## I. INTRODUCTION

With the increasing demand of energy and evolving grid, the power systems are also expanding. It is typical to have thousands of nodes for a distribution level power system, and a couple 100 nodes for transmission level systems. To analyze system robustness and fault propagation, researchers are looking into alternate methods to abstract the system. This allows for faster and more generic tools, which can learn the system, and abstract the information in more general terms.

Among these techniques, temporal causal diagrams (TCD) are very promising. TCD based approaches can abstract the information of physical systems into simple logical relationships between individual components. The ability of the model to learn system behavior from cause-effect models, and their use to anticipate the probable misoperation and propagation of this event in rest of the system distinguishes it from other approaches. The work in this paper is a part of achieving the objective of this project by developing a unique tool called “Reasoner” [1]. Reasoner deduces fault propagations using the TCD approach. The behavior of a physical system is analyzed using logical relationships between cause-effects. The reasoner (Fig. 1) observes and scrutinizes

relays’ responses for active system faults by comparing their outputs with ideal behavior. It hypothesizes potential misoperations (cyber faults) with a confidence metric. The analyzer (or Observer) is integrated to OpenDSS for fault analysis. This approach is better because of its ability to link the state of the systems with the events at multiple points throughout the system. Therefore, even when a small part of the system is compromised or not functioning properly, the reasoner can identify the discrepancies, using the event flags generated by rest of the system.

Since, the information from the events about the system is such a crucial part of the process; the reasoner needs very accurate relay models to get the most details from the system. The relay model presented here will provide the reasoner with additional details like the direction, fault type, in addition to the more accurate zone locations. This paper presents an evolved distance relay model, which resembles commercial relays more closely. Its functioning based on directionality, memory polarization and fault selection simultaneously, makes it much more useful compared to the traditional models using only a subset of these features. Additionally, the relay can be used independently for power flow studies using conventional software like Matlab or Python. Its implementation of mho element, with directional and fault selection supervision, and memory polarization, and ability to work with sampled transient/steady state data makes it a better model compared to other implementations.

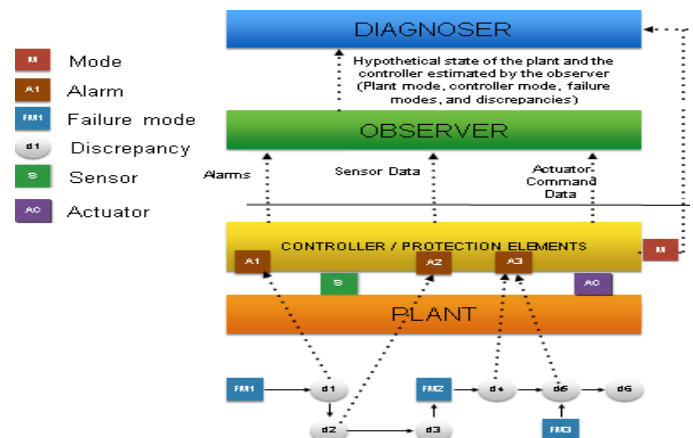

Fig. 1. The Reasoner – Hierarchical Flow of Information[1]

## II. THE TCD BASED REASONING APPROACH

The virtual distance relay is a part of the ‘Analyzer’ or the observer. The relays with appropriate settings for the corresponding lines are deployed throughout the power system. They monitor the system every time step, and send flags to the reasoner for diagnosis.

For the given system under study, a ‘Failure Mode and Discrepancy Mapping’ (FMDM) XML file is coded manually. This file contains an exhaustive set of the relay responses for ideal operations, throughout the system. Since the number of permutations will increase significantly for larger systems, a tool is in development to automate this process. However, the tool is outside the scope of this paper. The reasoner learns the system using this FMDM file.

When the system is in operation, the reasoner closely monitors the flags from all the relays. The reasoner hypothesizes the state of the system using these flags and its understanding of the system from the FMDM file. When it detects a discrepancy, the reasoner will propose different hypotheses about what it thinks could have happened with a confidence metric. Higher confidence metric means higher probability of the hypothesis being correct. Outliers in the system can be detected using this information. For instance, if one of the relays misoperated or was compromised, the reasoner will identify it, using events seen by other relays in the system. These hypotheses will be used to understand how an event can propagate across the system.

## III. INTERFACING WITH OPENDSS

OpenDSS is an open source simulation tool, more popular with the steady state analysis for distribution system modeling. It is possible to simulate a very large system in this tool, and perform analysis on an adjustable time step from milliseconds to years. For this work, OpenDSS was interfaced with the relay implementation in Matlab. Similar approaches can be adapted to work in other programming environments like Python.

The primary control code is written in Matlab, which calls OpenDSS via ActiveX server and communicates with it using the COM interface. The relay algorithm is also implemented in Matlab using loops to simulate steady state snapshots. Therefore, the relays in Matlab monitor the corresponding lines every time step. In other words, the corresponding bus voltages and currents are read every time step and passed through the relay to check for any possible faults.

## IV. RELAY MODELING

OpenDSS offers only steady-state values of voltages and currents as phasors. It is not useful to implement an algorithm which is dependent on sub-cycle data for fault detection/protection. The algorithms described here, primarily the memory polarization work with cycle and steady state phasor values effectively.

Relay implementation consists of two parts: 1) Implementing the protection element, and 2) Implementing the supervision. For successful performance of both, a proper polarization algorithm is vital. The corresponding algorithms and discussion are presented as under:

### A. Polarization

Polarization provides a stable reference for a majority of protection algorithms. For mho elements, it enables expansion of mho circle, as shown in Fig. 2. Expansion temporarily increases element’s reach and makes it more sensitive to faults.

Memory polarization causes the signal to persist in its initial state longer, in other words, have a memory of it. This is useful, because the voltages and currents usually change during faults or any other triggered behavior of the system. With memory polarization, relay can use the initial state longer. The implementation in this paper is an adaption of the algorithm presented in [2].

The original algorithm is more suited for simulations with instantaneous behavior (not steady state behavior). The modified version presented in (1) can be used with steady state simulators (like OpenDSS) also, which is not possible with the original version.

$$X_M(t) = \frac{X(t)}{16} + \frac{15}{16} \cdot X_M(t-1) \quad (1)$$

Here,  $X_M(t)$  = Memory polarized output of Signal  $X(t)$

### B. ‘m’ Calculation

Mho elements use specific calculations, also called ‘m’ equations, to estimate the distance of the load (or fault) point from the relay. ‘m’ equation as presented (not proposed) in [3].

The equation is given as:

$$m = \frac{\text{real}[VR \cdot V_{pol}^*]}{\text{real}[Z_{L1} \cdot IR \cdot V_{pol}^*]}$$

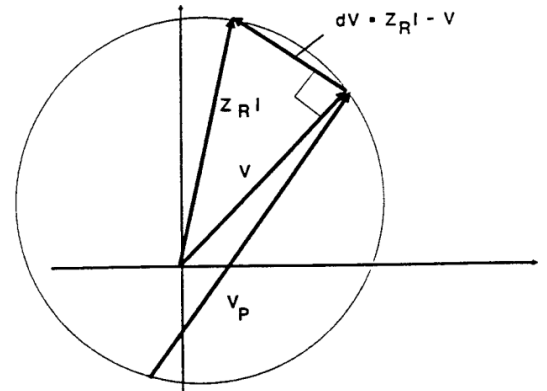

Fig. 2. Mho Characteristic Expansion [2]

where, VR and IR are defined in Table I for different faults. Based on the fault selection logic, and magnitude of zero sequence current ( $I_0$ ), fault types are selected, and quantities ‘VR’ and ‘IR’ are updated. In other words, mho element for all the unfaulted phases are desensitized to improve relay security.

TABLE I. REFERENCE CHART OF M-EQUATIONS FOR FAULT TYPES

Fault Type	VR	IR
AG	VA	IA + k0*I0
BG	VB	IB + k0*I0
CG	VC	IC + k0*I0

Fault Type	$V_R$	$I_R$
AB, ABG	$V_A - V_B$	$I_A - I_B$
BC, BCG	$V_B - V_C$	$I_B - I_C$
CA, CAG	$V_C - V_A$	$I_C - I_A$
ABC, ABCG	$V_I$	$I_I$

### C. Directional Element

Directional element plays a supervisory role for many protection elements including distance relays. It improves relay's selectivity and security by identifying if the fault is in front of the relay or behind it. In this work, the directional implementation (2) as proposed in [4] was used. It states that,

$$Z_1 = \frac{V_1 - V_{1\_PRE}}{I_1 - I_{1\_PRE}} \quad (2)$$

Here,  $Z_1$  is the positive sequence impedance as seen by the element, and  $X_{1\_PRE}$  are the pre-fault values for positive sequence quantity of 'X'. It is verified if  $Z_1$  lies in the IIIrd or Ist quadrant, hence referring to a forward or reverse fault respectively.

For the implementation for this paper, the memory polarized quantities are used in place of pre-fault voltages/currents, as they have similar behavior. As discussed earlier, any sudden change in the quantities isn't immediately reflected in the resultant, giving it a pre-fault like identity. Results are shown in Section VII.

### D. Fault Type Selection

Use of polarized quantities leads to dynamic mho elements with expandable mho characteristics. While this increases sensitivity for faults with higher fault impedance, it also makes the elements more susceptible to operation for unintended fault types [2]. Therefore, fault type selection is very important, and helps relay maintain security while increasing sensitivity.

[5] presents one of the modern algorithms used by commercial relays for fault type selection. The same has been implemented in this paper. Essentially, the angles between  $I_0$  and  $I_2$  are compared, and based on the angle difference between them, a corresponding fault sector is identified (Fig. 3). Table II presents a concise version of the selection logic. Note that, a majority of the faults will be covered by the region covered by this logic. Future work will include logic to include the rare events in the missing sectors.

Note that, if the angle difference falls between the regions identified, additional analysis of fault resistance can be used to identify the corresponding faulted phase. However, for most cases (including the ones studied for this paper), even with fault resistances, the comparison outside Table II is beyond the scope. Ref. [6] can be referred for a more complete algorithm.

TABLE II. FAULT TYPE SELECTION

$\angle I_2 - \angle I_0$	Conclusion
+/- 30 degrees	Sector A(AG/BC)–Element with lower reach asserts
[-90,-150] degrees	Sector B(BG/CA)–Element with lower reach asserts
[90,150] degrees	Sector C(CG/AB)–Element with lower reach asserts

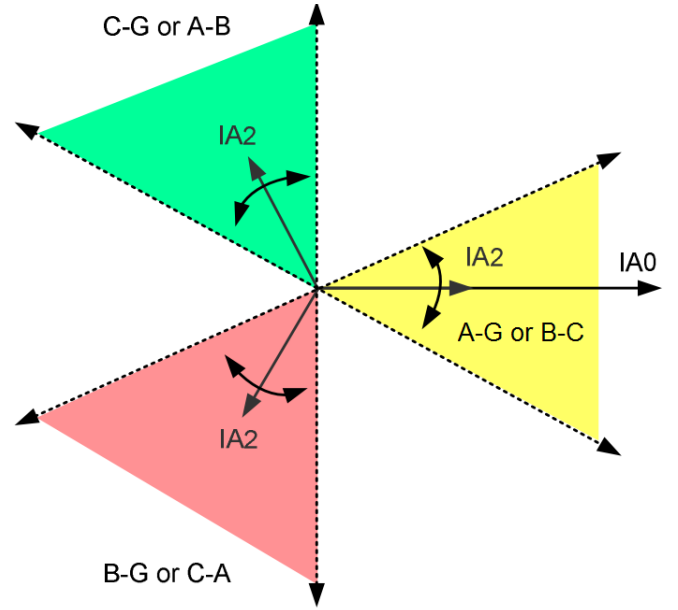

Fig. 3. Fault Type Selection – Algorithm [2]

## V. TEST SYSTEM

For testing the effectiveness of the relay implementation, the classic 115kV transmission system from [6] was chosen. Fig. 4 shows the one-line diagram of the test system.

Table III presents the line parameters for the test system. Note that, the original system was meant for power flow studies only. Therefore, the zero sequence and positive sequence impedances are the same. The line parameters presented here consider mutual coupling, and approximate, " $Z_0 = 3 \cdot Z_1$ ". In addition, to test for uncovered segments of the system, line between buses '1' and '4' was changed to '4' times the smallest line. Originally, it was '3' times long.

## VI. MAPPING THE FAULT SCENARIOS

To demonstrate the system better pictorially, the test system is redrawn as color coded line segments, such that the length of each of the segment corresponds to the length of the line, relative to each other. Table IV presents the length of the lines, with respect to each other.

Fig. 5 presents the redrawn test network. Zones of each relay are mapped on the diagrams. There is a unique image for each pair of relays. For simplicity, the diagram shows only forward zones. 'Line of interest' refers to the line on which the relay pair is located. The lines connected immediately to the buses other than the line of interest are marked as reverse fault zones. This means that ideally, the relay should flag a reverse fault for a fault on any of its sister branches from the same bus. Fig. 6 describes one of the mapping of faults throughout the system (for relays on L1-2). Five similar mappings are drawn for the other lines. This information is tabulated, and then coded into the FMDM file. Table V presents a part of this in here.

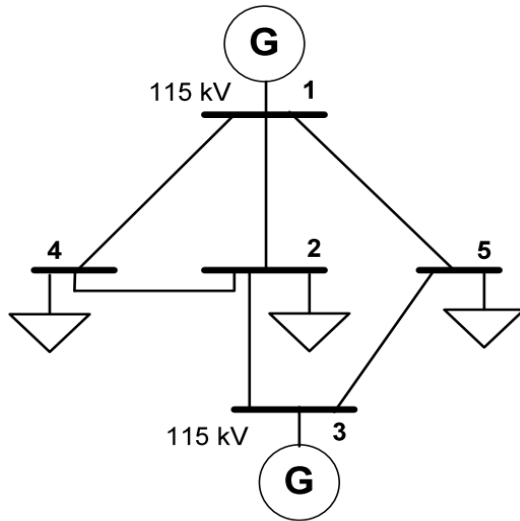

Fig. 4. Test System – Model Power System from [6]

TABLE III. LINE PARAMETERS FOR TEST SYSTEM [6]

Bus		R1 (ohms)	X1 (ohms)	R0 (ohms)	X0 (ohms)
From	To				
1	2	13.22	52.9	39.66	158.7
1	4	26.44	105.8	79.32	317.4
1	5	6.61	26.45	19.83	79.35
2	3	6.61	26.45	19.83	79.35
2	4	13.22	52.9	39.66	158.7
3	5	6.61	26.45	19.83	79.35

TABLE IV. EQUIVALENT REPRESENTATION : TEST NETWORK AND CORRESPONDING RELAY SETTINGS

Line	Pos. Seq. Impedance (ohms)	Equivalent Line Length	'Z1 reach'	'Z2 reach'	'Z4 reach'
L1-2	$13.22 + j.52.9$	'2.X'	$0.8*LL^*$	$1.2*LL$	$1.2*LL$
L1-4	$26.44 + j.105.8$	'4.X'	$0.8*LL$	$1.2*LL$	$1.2*LL$
L1-5	$6.61 + j.26.45$	'X'	$0.8*LL$	$1.2*LL$	$1.2*LL$
L2-3	$6.61 + j.26.45$	'X'	$0.8*LL$	$1.2*LL$	$1.2*LL$
L2-4	$13.22 + j.52.9$	'2.X'	$0.8*LL$	$1.2*LL$	$1.2*LL$
L3-5	$6.61 + j.26.45$	'X'	$0.8*LL$	$1.2*LL$	$1.2*LL$

\*LL – Line Length

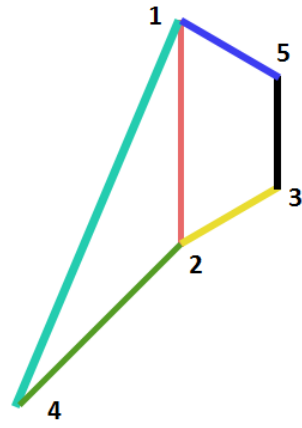

Fig. 5. Pictorial Representation - Test System Generic

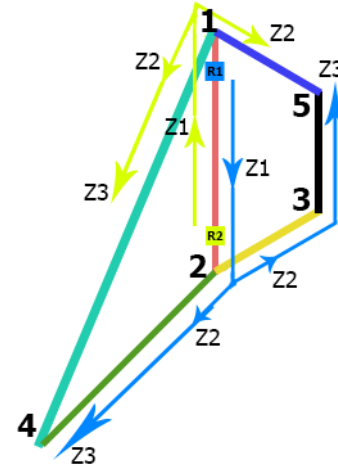

Fig. 6. Pictorial Representation - Test System showing Relay zone coverage for Line 1-2

#### A. Nomenclature

1) *Relay*: R'X'YZ: Here, 'YZ' identifies the transmission line from the system by identifying the 'from bus' as 'Y' and 'to bus' as 'Z'. 'X' = 1 or 2, which corresponds to the From Bus 'Y' or To Bus 'Z'. For eg: 'R1\_12' is pointing at the relay installed on the Bus '1' side of the line 'L12'. It is marked as a blue box in Fig. 6.

2) *Table Entries*: XX\_LYZ\_B: Here, 'XX' denotes the percentage of line 'YZ' covered by the Zone measured from bus 'B'. For eg. '0.8\_L12\_2' means that the zone covers 80% of the line 12 from Bus '2'. Sometimes, when the relay zone covers only a part of the line, 'XX' is replaced by 'PP – QQ'. Eg., '(0.1-0.4)\_L12\_2' means from '10%' to '40%' of the Line '12' from Bus '2'.

3) *Out-of-Reach*: O (NA) depicts that the zone is not available (NA) because the location of the fault is out of the relays reach.

4) *Reverse fault*: R (NA) depicts that the zone is not available (NA) because the location of the fault is behind the relay (reverse fault). For the given study, the reverse zone is not included as a zone in the relay for simplification. Future iterations will have these details.

TABLE V. EQUIVALENT REPRESENTATION : TEST NETWORK AND CORRESPONDING RELAY SETTINGS

Line	R1_12			R2_12		
	Z1	Z2	Z3	Z1	Z2	Z3
L1-2	0.8_L12_1	1_L12_1	1_L12_1	0.8_L12_2	1_L12	1_L12_2
L1-4	R (NA)	R (NA)	R (NA)	O (NA)	0.1_L14_4	(0.1 - 0.4)_L14_4
L1-5	R (NA)	R (NA)	R (NA)	O (NA)	0.4_L15_5	0.6_L15_5
L2-3	O (NA)	0.4_L23_2	0.6_L23_2	R (NA)	R (NA)	R (NA)
L2-4	O (NA)	0.2_L24_2	0.8_L24_2	R (NA)	R (NA)	R (NA)
L3-5	O (NA)	O (NA)	1_L53_5	O (NA)	O (NA)	1_L53_3

VII. SIMULATION RESULTS – RELAY VALIDATION

Table VI presents the different faults that were simulated on the system. The relay is implemented on Line between buses ‘2’ and ‘4’, looking from ‘2’ to ‘4’. Therefore, any faults on the line 2-4 will be forward. Accordingly, the faults are simulated on Lines 2-4, and 1-2. Line 1-2 will check if the directional element correctly identifies reverse faults and blocks the relay for these faults.

TABLE VI. FAULT TESTS CONDUCTED IN OPENDSS

Line	Fault Type	VR
Line.2-4	AG	50%
	ABG	50%
	AB	50%
	ABC	50%
Line.1-2	AG	50%
	ABG	50%
	AB	50%
	ABC	50%

TABLE VII. RESULTS

Line	Fault Type	Fault Location	‘m’	Direction
Line.2-4	AG	50%	0.6683	‘F’
	ABG	50%	0.5	‘F’
	AB	50%	1.1	‘F’
	ABC	50%	0.5	‘F’
Line.1-2	BG	50%	-5.98	‘R’
	ABG	50%	5.4	‘R’
	AB	50%	7.089	‘R’
	ABCG	50%	-4.3	‘R’

Results (Table VII) show that the relay performed really well in all cases, except for ‘one’ for a forward L-L fault. For a L-L fault, the relay saw a zone 2 fault. Here, additional

conditioning is required to locate the fault properly. Since the remote end saw the fault properly, POTT scheme will allow to the relay to issue a fast trip.

Figs. 7-12 present the outputs from the mho Element and directional element of the relay for 1) Forward ‘A-G’ fault, 2) Forward A-B Fault, and C) Reverse A-G fault. Note that the negative output torque from directional element represents a forward fault and positive (or zero) value indicates a reverse fault. Only few important plots are presented here for brevity.

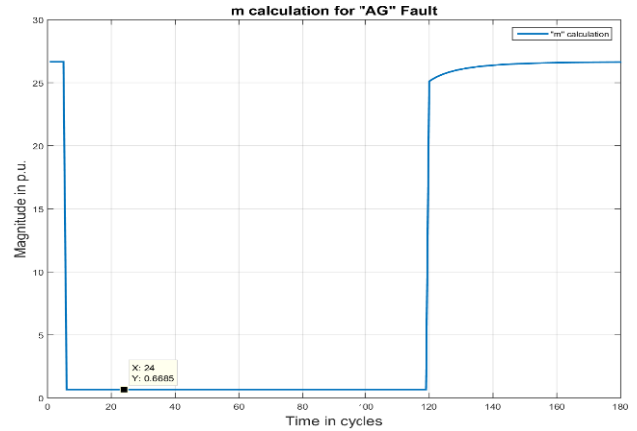

Fig. 7. ‘m’ calculation plot – Forward ‘A-G’ Fault

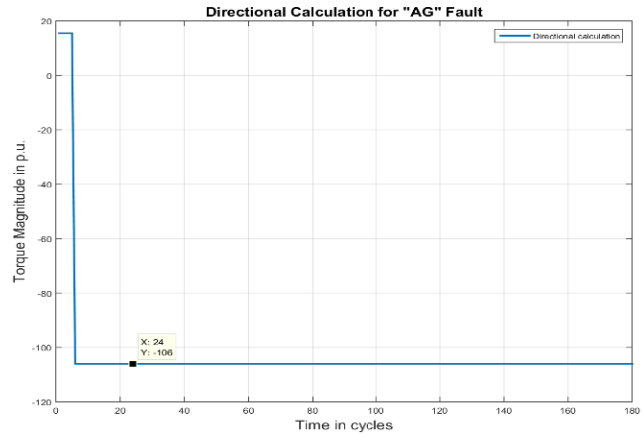

Fig. 8. Directional Calculation plot – Forward ‘A-G’ Fault

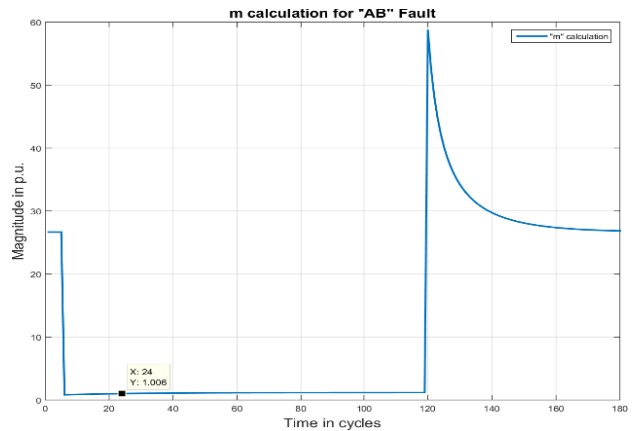

Fig. 9. ‘m’ calculation plot – Forward ‘A-B’ Fault

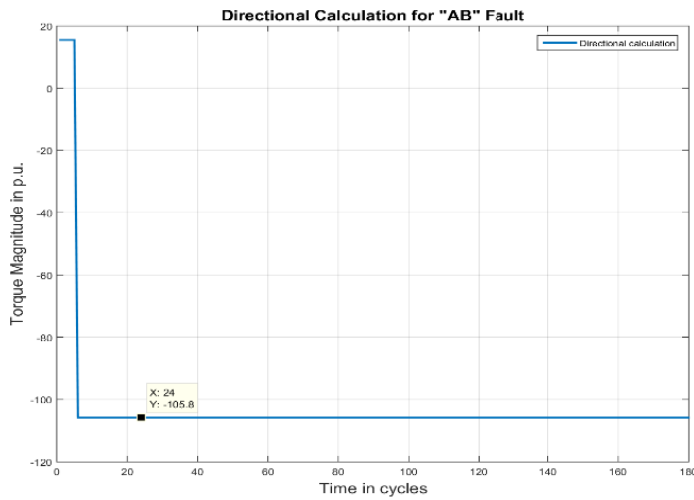

Fig. 10. Directional Calculation plot – Forward ‘A-B’ Fault

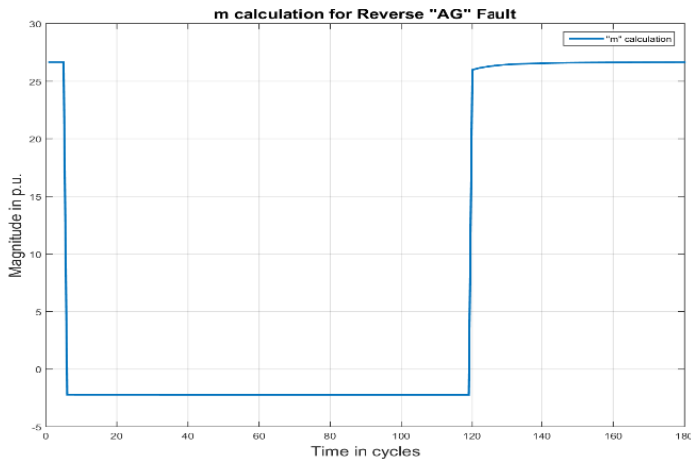

Fig. 11. ‘m’ calculation plot – Reverse ‘A-G’ Fault

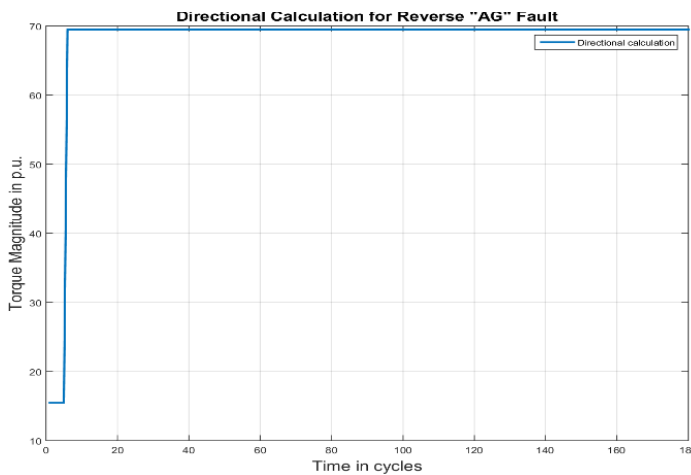

Fig. 12. Directional Calculation plot – Forward ‘A-G’ Fault

Fig. 13 shows the output of the memory polarized voltage element. Note that even after a lot of time steps, the memory voltage stays significant to support the mho element.

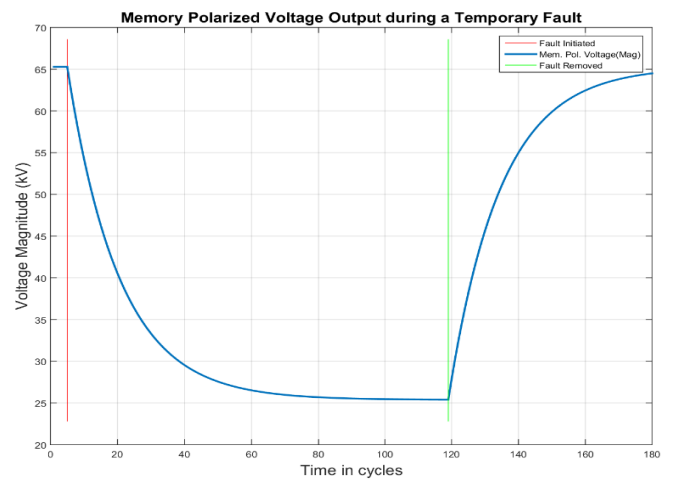

Fig. 13. Output from Memory Polarized Element during a Fault

## VIII. CONCLUSION

This paper presents a unified methodology to implement a more detailed distance relay in Matlab with script based simulation tools like OpenDSS. The algorithm presented worked well with steady state phasor data. Modified memory polarization algorithm is presented. Fault was located accurately for all cases except one. This one test detected a forward fault at 110% instead of 50%. However, given that the remote relay still sees a forward fault, the relays will issue an instantaneous trip under POTT scheme. Next, the steps to create the FMDM file using exhaustive permutations from the line model are presented. The abstraction then generated, will be used by the Reasoner to analyze the test system and propose hypotheses based on the events. By the virtue of the relay model, accurate details about the distance of the fault and its direction are available to the Reasoner. Using the FMDM file and the input flags from the system relays, the reasoner is able to form better hypotheses of the event occurrence, and possible sequence of events with more confidence.

## IX. ACKNOWLEDGEMENT

This work is funded in part by the National Science Foundation under the award number CNS-1329803.

## X. REFERENCES

- [1] Mahadevan, N.; Dubey, A.; Karsai, G.; Srivastava, A.; Liu, C., "Temporal Causal Diagrams for Diagnosing Failures in Cyber-Physical Systems," presented at Annual Conference of the Prognostics and Health Management Society, 2014
- [2] E. Schweitzer III, "New Developments in Distance Relay Polarization and Fault Type Selection," in Proc. 16th Annu. Western Protective Relay Conf., 1994, pp. 1–20.
- [3] G. Benmouyal, A. Guzman, R. Jain, "Tutorial on the Impact of Distance Element Resistance Coverage," in Proc. 40th Annu. Western Protective Relay Conf., 2013, pp. 1-14.
- [4] P. G. McLaren, G. W. Swift, Z. Zhang, E. Dirks, R. P. Jayasinghe, and I. Fernando, "A new directional element for numerical distance relays," *IEEE Transactions on Power Delivery*, vol. 10, no. 2, pp. 666–675, Apr. 1995.
- [5] D. Costello and K. Zimmerman, "Determining the faulted phase," in *Protective Relay Engineers, 2010 63rd Annual Conference for*, 2010, pp. 1–20.
- [6] [ref:book\_stevenson] J. J. Grainger and W. D. Stevenson, *Power system analysis*. Power Flow Ex., Pg 219-225, McGraw-Hill New York, 1994.